

Marine toilets
system

PLANUS

Who we are



m.giovannini@planus.biz

Marco Giovannini

- 1986 President of Giovannini Ceramiche Srl.
- 1988 Devised and constructed the first toilet with the Vortex system for marine applications.
- 1991 Founded the Tecma di Marco Giovannini creating a market for his new toilet system amongst customers who had previously preferred alternative systems.
- 1997 Founded Tecma Srl and served as its President until the sale of the company.
- 2009 Appointed President of the new company **PLANUS SpA**.



c.desantis@planus.biz

Cristiano De Santis

- 1992 Began collaborating with Marco Giovannini in the role of sales operator, later becoming Sales Director and Managing Director of Tecma Srl.
- 2009 Became Sales Manager of **PLANUS SpA**.



a.tagliaferri@planus.biz

Angelo Tagliaferri

- 1983 Nominated "Best Foreign Apprentice" at Trumpf GmbH, Stuttgart.
- 1992 Qualified in "Workgroup and Solution of Problems" at Daimler-Benz AG.
- 1993 Still at Daimler-Benz, he became Department Head and Instructor, New Work Systems and later took the role of coordinator in an experimental project.
- 2000 Began collaboration with Marco Giovannini as Production Manager of Tecma Srl.
- 2009 Appointed Production Manager of **PLANUS SpA**.



a.presti@planus.biz

Alessio Presti

- 1998 At Aprilia Spa, he collaborated in the initial development of the company's first Touring motorbike.
- 2000 Began collaboration with Marco Giovannini as Project Manager of Tecma Srl.
- 2009 Appointed Project Manager of **PLANUS SpA**.

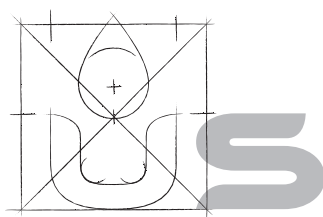

Experience is the guarantee.

Planus was born out of the in-depth experience gained by our staff over more than twenty years of collaboration with shipbuilders.

The basis of our knowledge is due to the continuous support we supply directly to the shipyard and on board, and to our constant adaptation to the needs of the customers.

We know what is required to earn out place as part of your product



A step ahead

New “Family” switch

A homely design for a greater simplicity and ease of use (in addition to traditional control panels).



Noiseless operation

Important innovations make the PLANUS toilet even quieter than customers have come to expect.



Toilet flush system

Dripping water inlet for toilet flushing: silent, reliable and effective.



Stainless steel one-way valve

The stainless steel valve shutter solves the inevitable problem of tiny deformations present in plastic-moulding components, which can damage its functionality. Plastic components can never be perfectly uniform across various production batches. The stainless steel shutter, on the other hand, ensures a perfectly level, hard-wearing surface.



Grey water transfer unit

Stainless steel units to automatically pump out waste water. Perfectly sealed to the IP67 standard, for continuous usage.



Vision and Impact: the first ranges of complete bathroom suites

Complete bathroom suites for the nautical market are now available. Toilet, bidet, wash basins, shower tray and bath tub, all made to the same design.



A bidet for each toilet

Complete range of bidets for the perfect match with all the toilets.



Colours

All the bathroom fittings are available in 12 different colours.



Index

THE RANGES

- Vision p. 12
- Impact p. 16
- Sky p. 20
- Race p. 22
- Artic p. 24
- Elite p. 28



TECHNICAL SPECIFICATIONS AND ACCESSORIES

- Operating principles p. 32
- Plumbing p. 34
- Wiring p. 38
- Technical specifications p. 39
- Flush controllers p. 40
- Accessories p. 42
- Exploded views p. 44

GREY WATER TRANSFER UNIT

- Pro-Lift p. 48







Vision range

Technique, design, coordinated bathroom suites.









Impact range

A sea of colours.



Planus offers all the entire bathroom range in 12 different colour schemes.

-  Orange
-  Red
-  Green apple
-  Lilac
-  Brown mat
-  Cement grey
-  White
-  White mat
-  Ivory
-  Ivory mat
-  Black
-  Black mat



The ranges.





Vision





The Vision range includes the entire coordinated bathroom suite.

Vision

Toilet

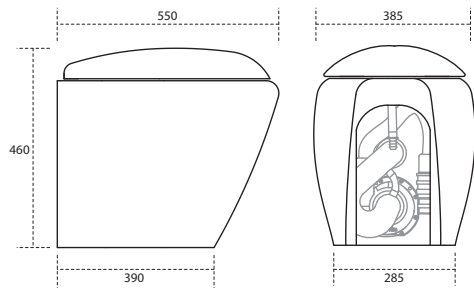

Bidet

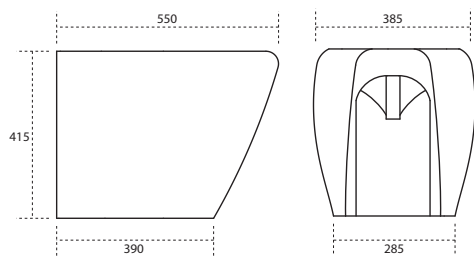

Wash basin 47

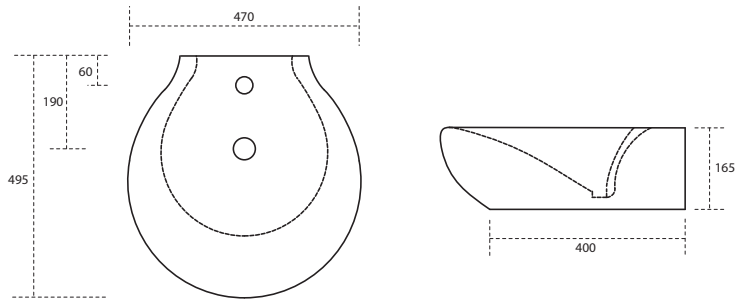

Wash basin 70

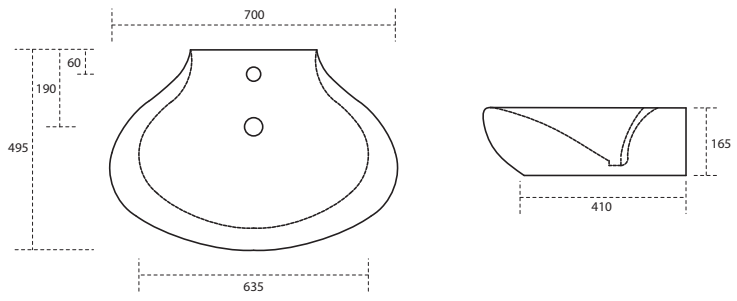

Wash basin 90

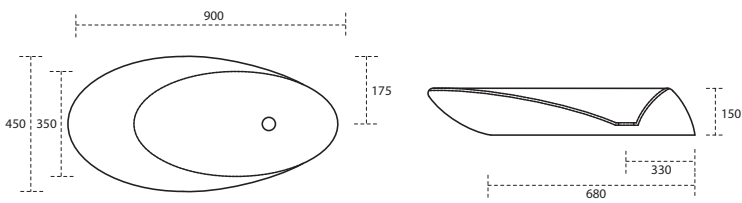

Shower tray

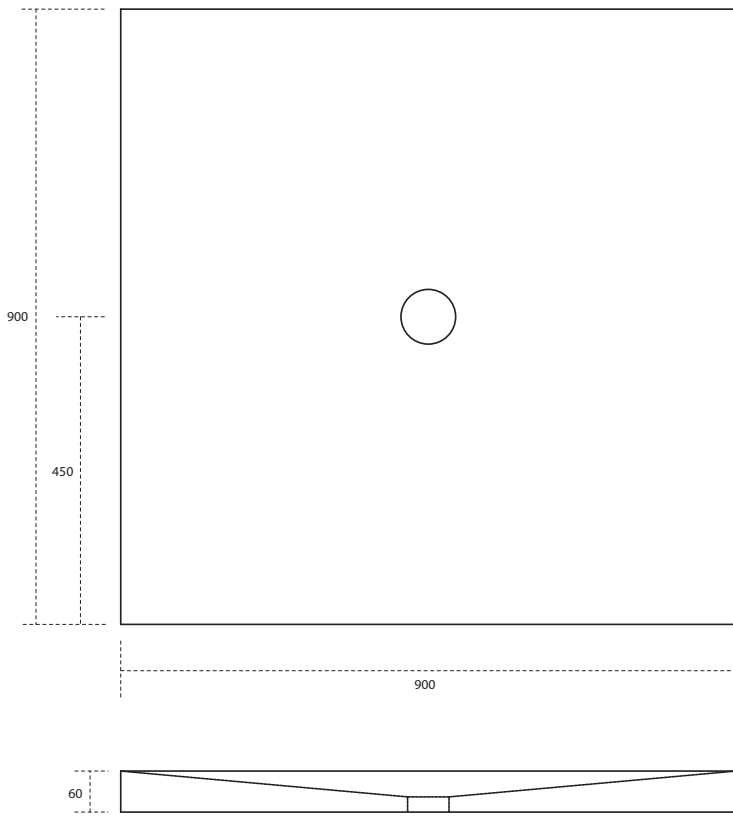

Bath tub

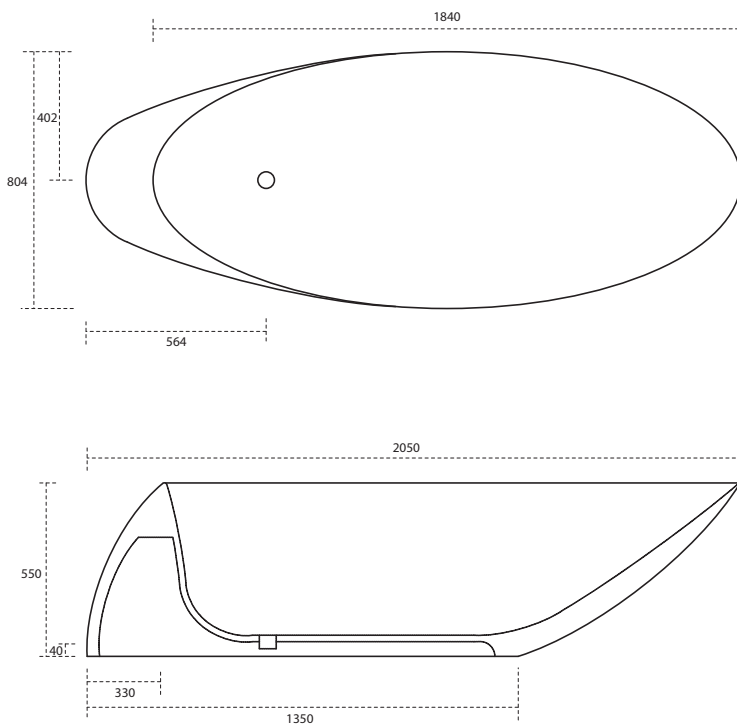

Impact





The Impact range includes the entire coordinated bathroom suite.

Impact

Toilet

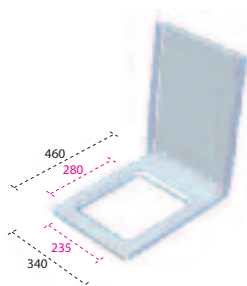
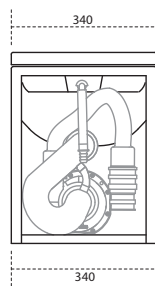
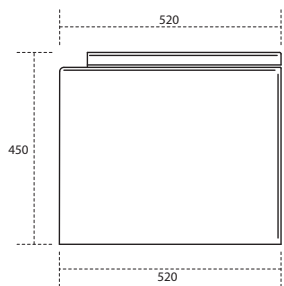

Bidet

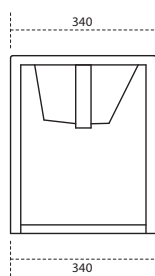
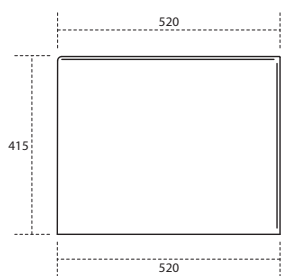

Wash basin 42

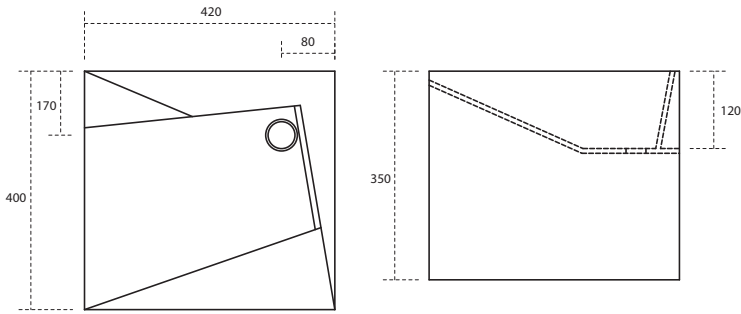

Wash basin 65

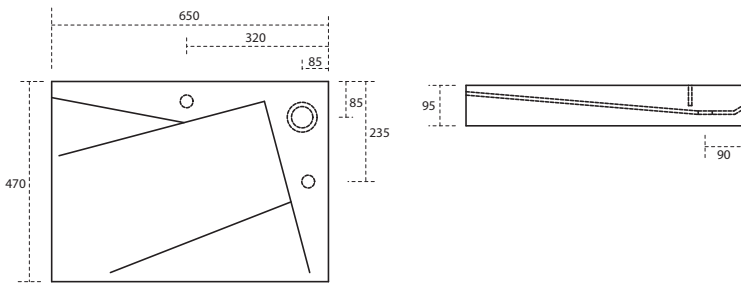

Right wash basin 95

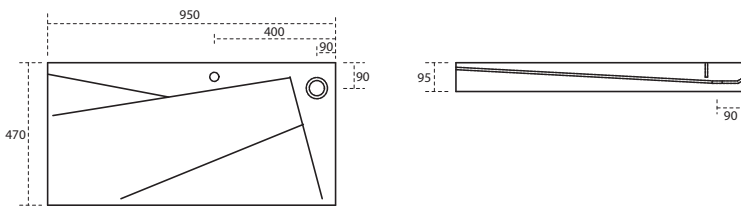

Left wash basin 95

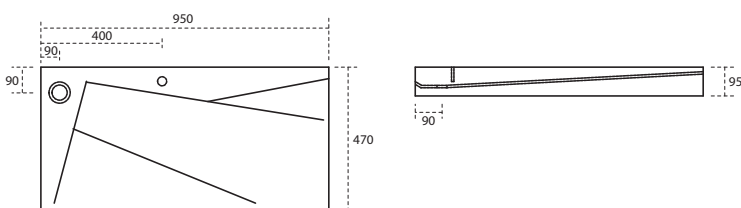

Shower tray

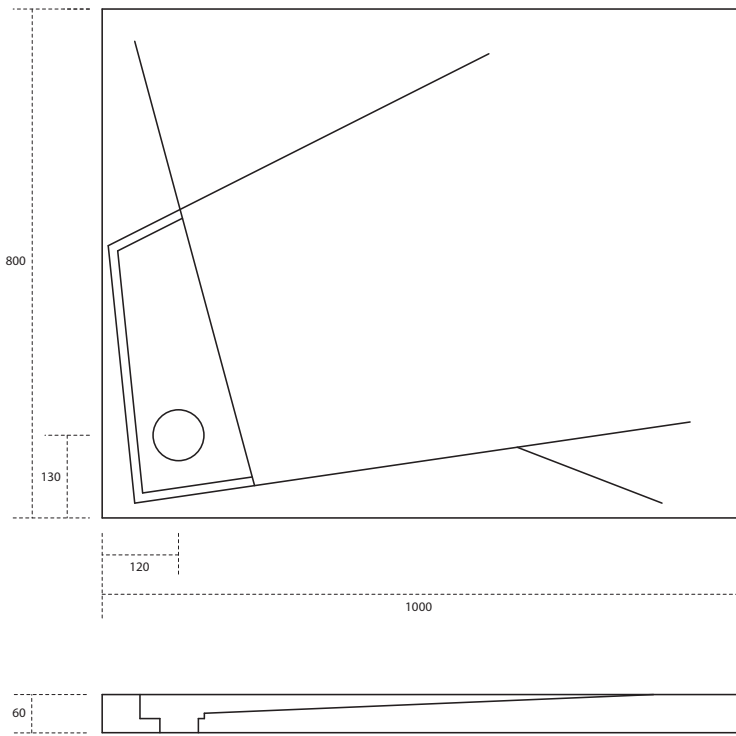

Bath tub

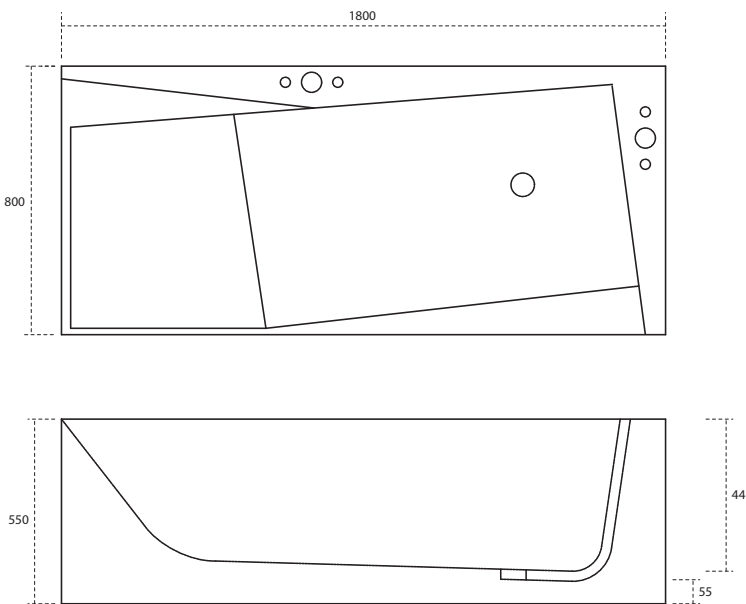





The removable cover below makes it easy to install the wall-mounted toilet.

Sky

Toilet

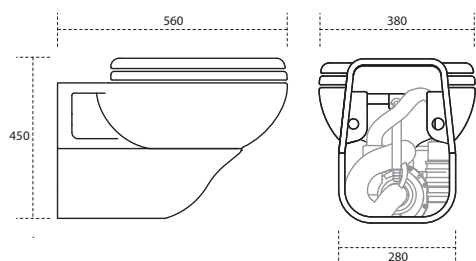

Bidet

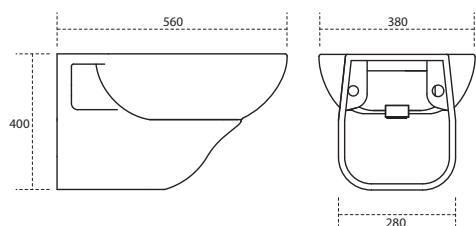

Race



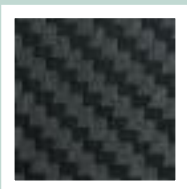

Full Carbon



Extra light



Made in both Standard and Short sizes



Surface finishing: visible carbon fibre mat

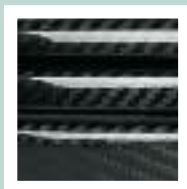

Surface finishing: visible carbon fibre bright



Surface finishing: painting in any RAL colour desired

Race Standard

Toilet

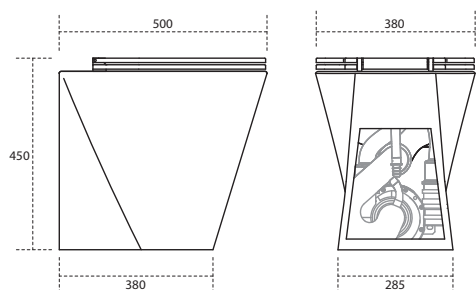

Bidet

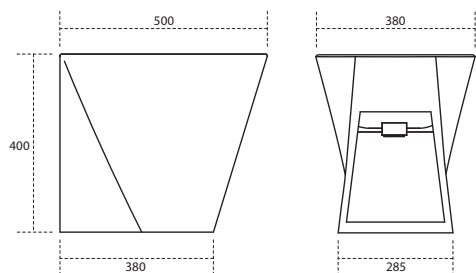

Race Short

Toilet

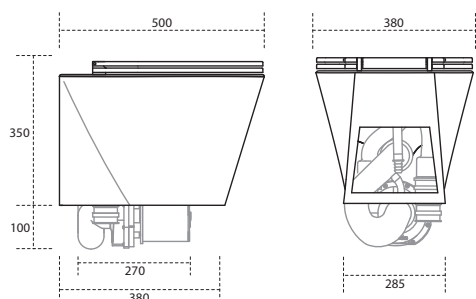

Bidet

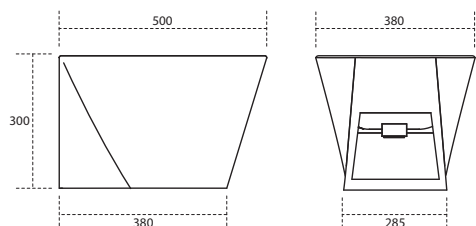

Artic





Complete range for any kind of installation.



Toilet also available in the integrated bidet version (see page 43).

Artic Plus Standard

Toilet

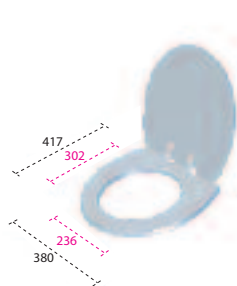
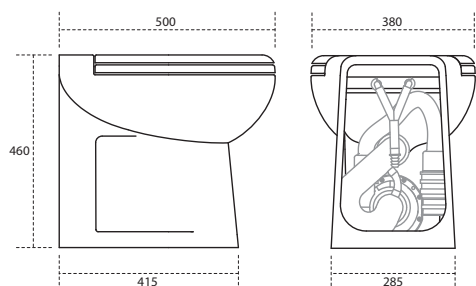

Bidet

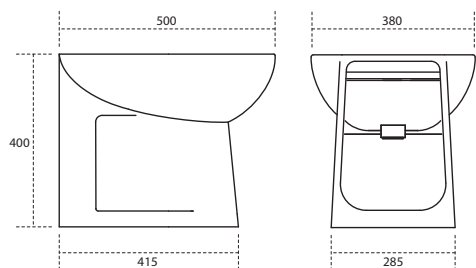

Artic Plus Short

Toilet

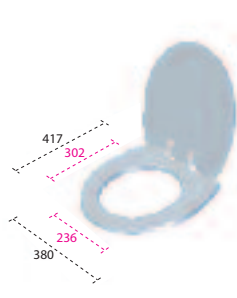
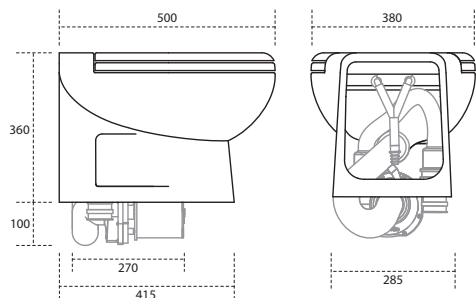

Bidet

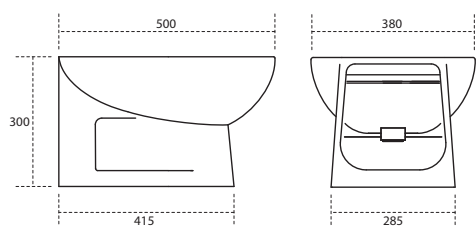

Artic Standard

Toilet

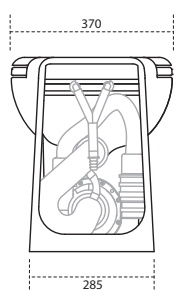
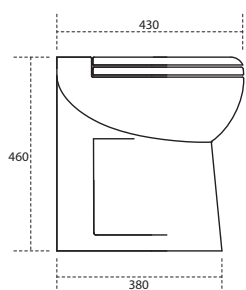

Bidet

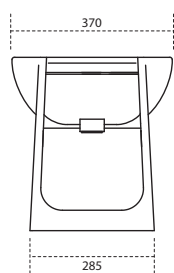
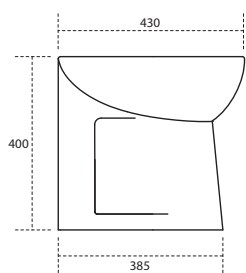

Artic Short

Toilet

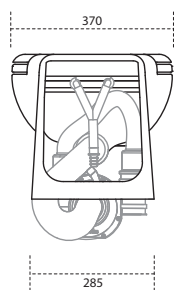
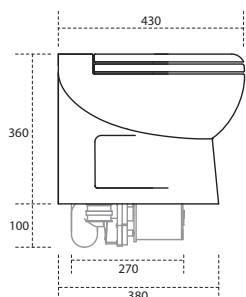

Bidet

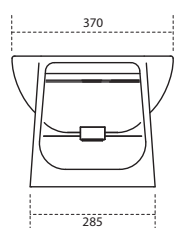
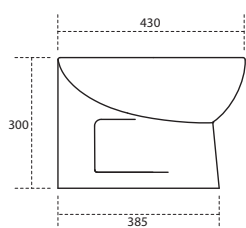

Artic Cut Standard

Toilet

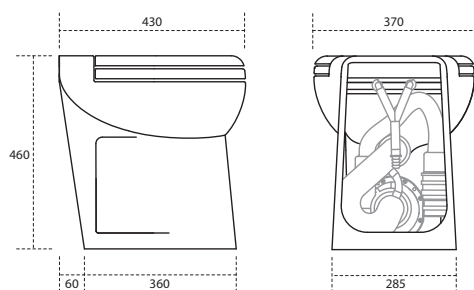

Artic Cut Short

Toilet

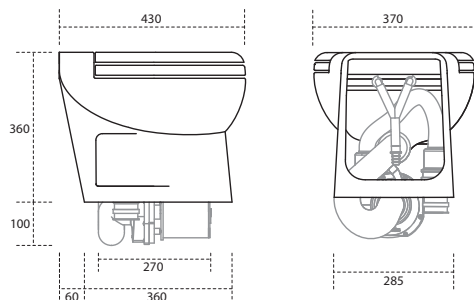

Reduced width bidet

Bidet "Mini" Plus

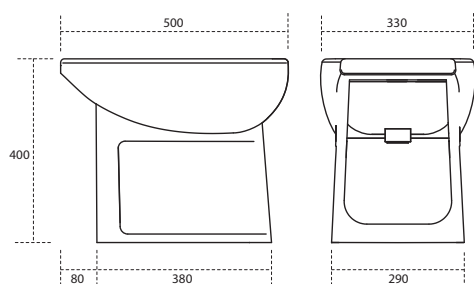

Bidet "Mini" Short

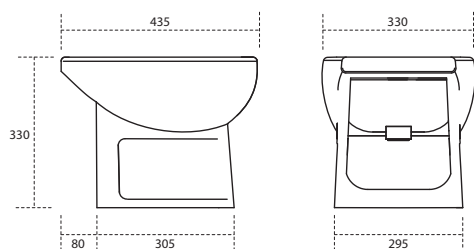





Made in both Standard and Short sizes.



Toilet also available in the integrated bidet version (see page 43).

Elite Standard

Toilet

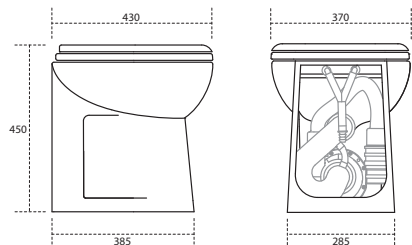

Bidet

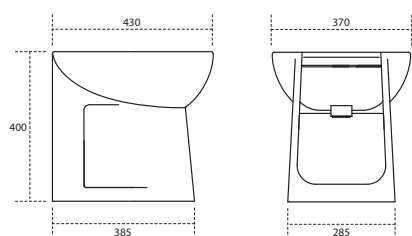

Elite Short

Toilet

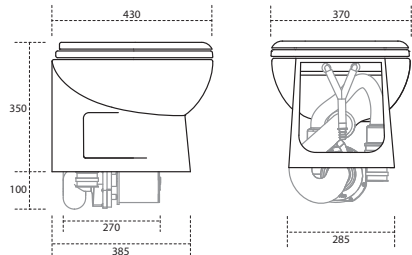

Bidet

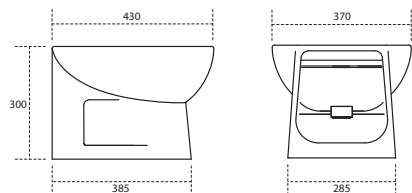

Reduced width bidet

Bidet "Mini" Plus

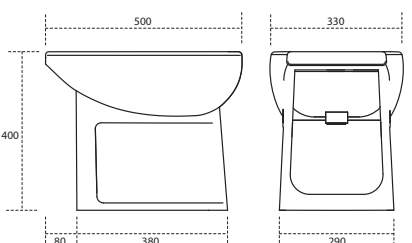

Bidet "Mini" Short

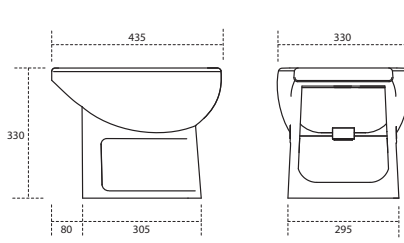

Technical specifications

A light blue horizontal bar is positioned below the title 'Technical specifications', extending across the width of the page.

and accessories.



Operating principles

Vortex system

Over the years, we have developed and refined the Vortex system.

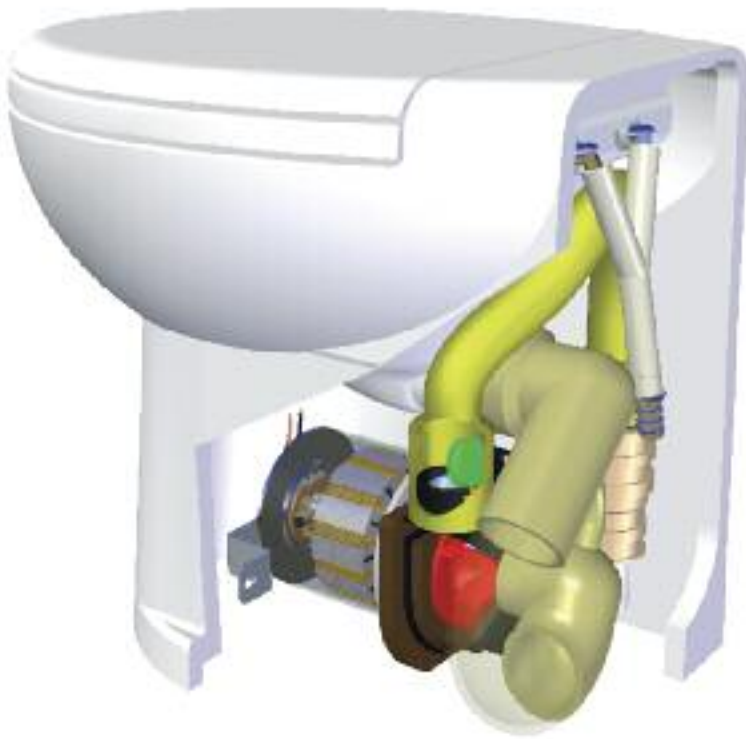

The high speed of rotation of the VORTEX pump and the geometric design of its piping create a great vacuum able to remove water and organic waste from the bowl.

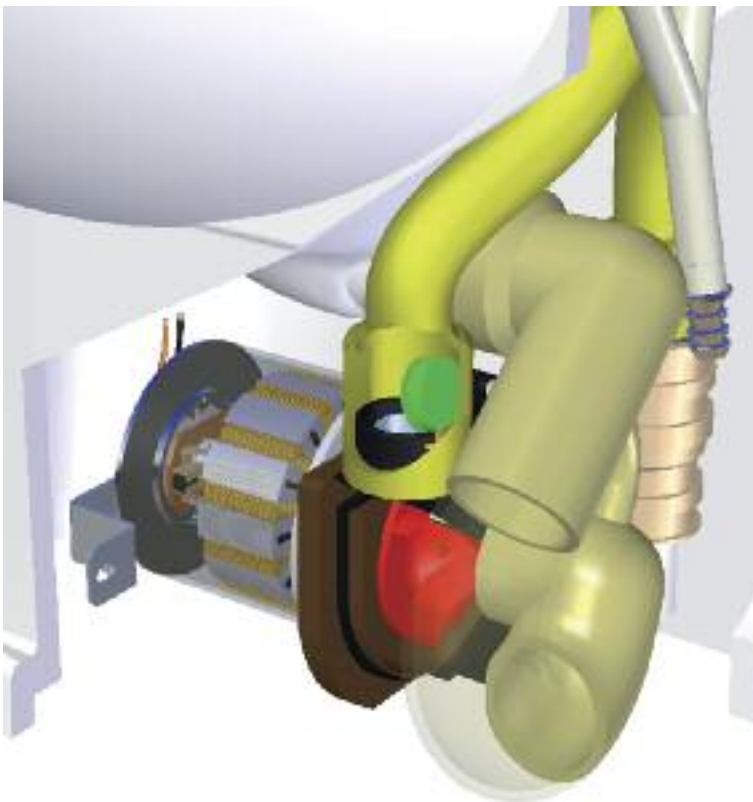

The high level of performance ensures the greatest possible flexibility in planning the route of the discharge hoses, allowing it to reach significant distances and heights.

Main operational components



Flush controller

Pressure on the switch activates the automatic flush sequence.



Water inlet devices

The water inlet component required depends on the type of installation desired (see page 34).



Discharge pump

The toilet can discharge to the collecting tank or overboard (see page 36).

Fresh water inlet

Simplicity of installation and greater hygiene.

Toilets with centralized water inlet.



Examples of equipment are given for purely illustrative purposes.

COMPONENTS SUPPLIED FOR EACH TOILET:



1. Bowl



2. Solenoid valve



3. Flush controller

COMPONENTS NOT PROVIDED:



4. Automatic water pressure pump

Sea water inlet

Saving fresh water.

Toilets with centralized water inlet

One seacock for the water inlet for all the toilets on board.

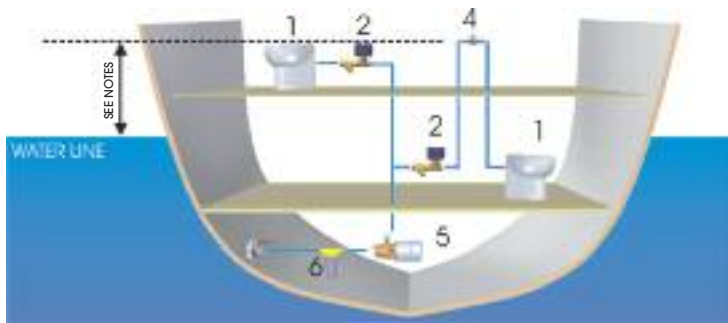

Examples of equipment are given for purely illustrative purposes.

COMPONENTS SUPPLIED FOR EACH TOILET: COMPONENTS NOT PROVIDED:

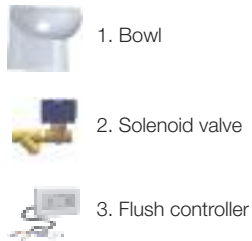

OPTIONAL EXTRA:

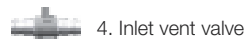

Toilet with independent water inlet

Each toilet is completely independent.

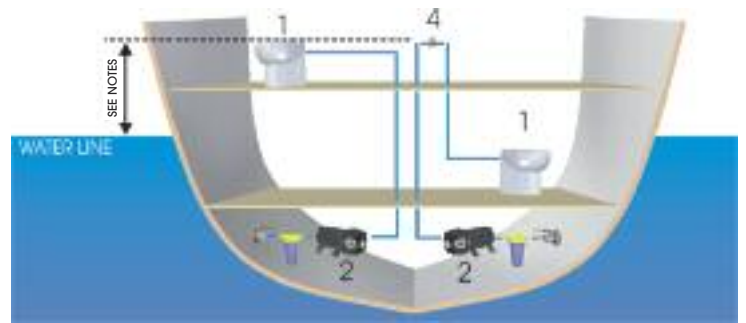

Examples of equipment are given for purely illustrative purposes.

COMPONENTS SUPPLIED FOR EACH TOILET:

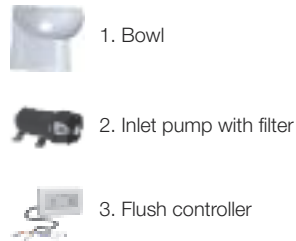

OPTIONAL EXTRA:

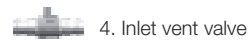

NOTES



Examples of equipment are given for purely illustrative purposes.

IMPORTANT

1. If the toilet is placed beneath the water line, the installation of a ventilation valve at a sufficiently higher level is needed.
2. All possible navigational conditions must be taken into account when estimating the water line.
3. The seacock must be installed properly to avoid that pressure is generated on the plumbing during sailing.

Waste discharge

Freedom to choose the route of the discharge hoses.

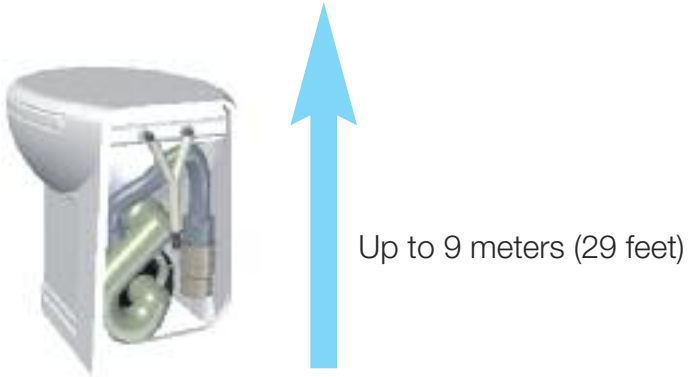

The high performances of the VORTEX pump placed inside the base of the ceramic bowl foot gives the greatest possible flexibility in planning the route of the discharge hoses.

The VORTEX pump is capable of discharging into a holding tank, even at a significant distance, or directly to the sea (see notes).

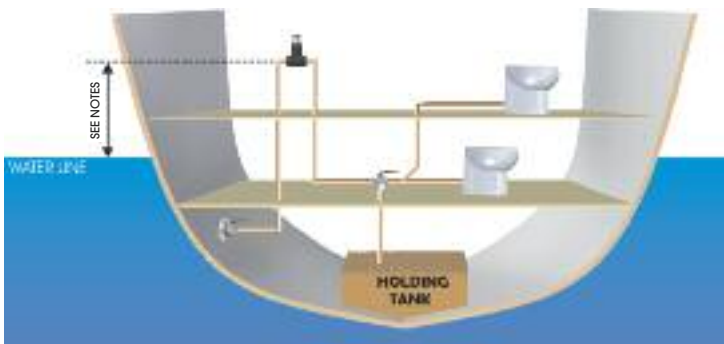
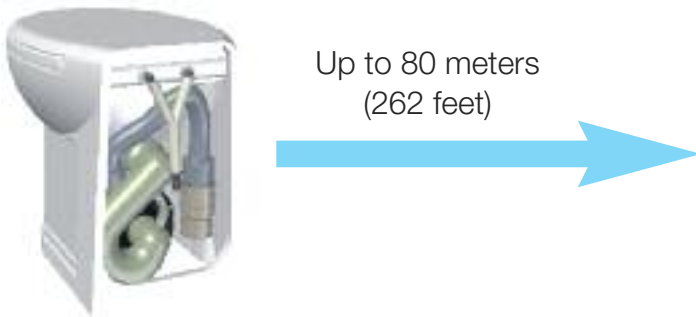

Examples of equipment are given for purely illustrative purposes.



Examples of equipment are given for purely illustrative purposes.

OPTIONAL EXTRA:



1. Outlet vent valve

NOTES

IMPORTANT

1. If the toilet is placed beneath the water line the installation of a ventilation valve at a sufficiently higher level is needed.
2. All possible navigational conditions must be taken into account when estimating the water line.
3. The seacock must be installed properly to avoid that pressure is generated on the plumbing during sailing.
4. The discharge into the sea is subject to specific local rules.

Fresh water centralized system

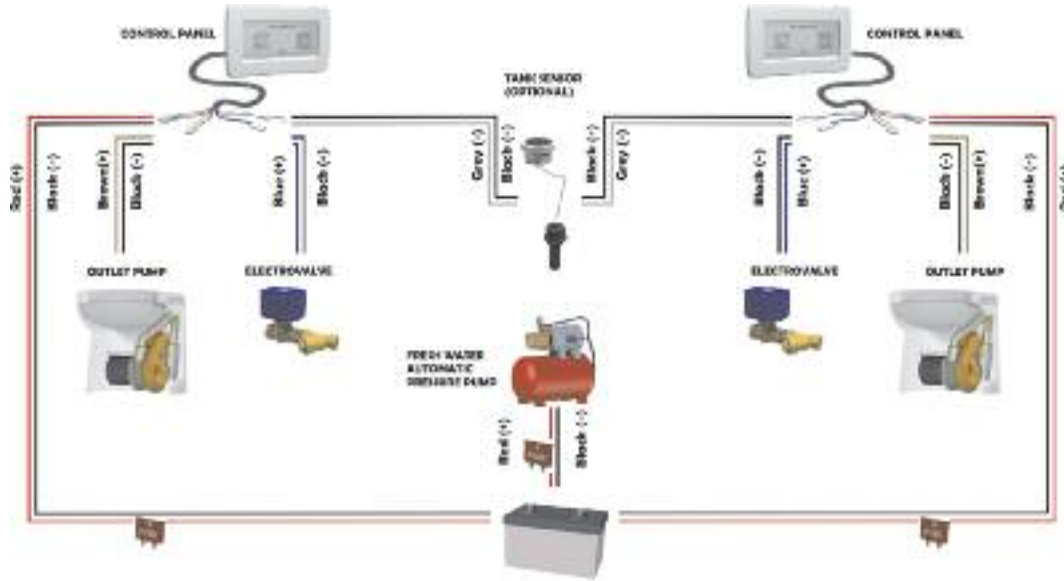

Sea water centralized system

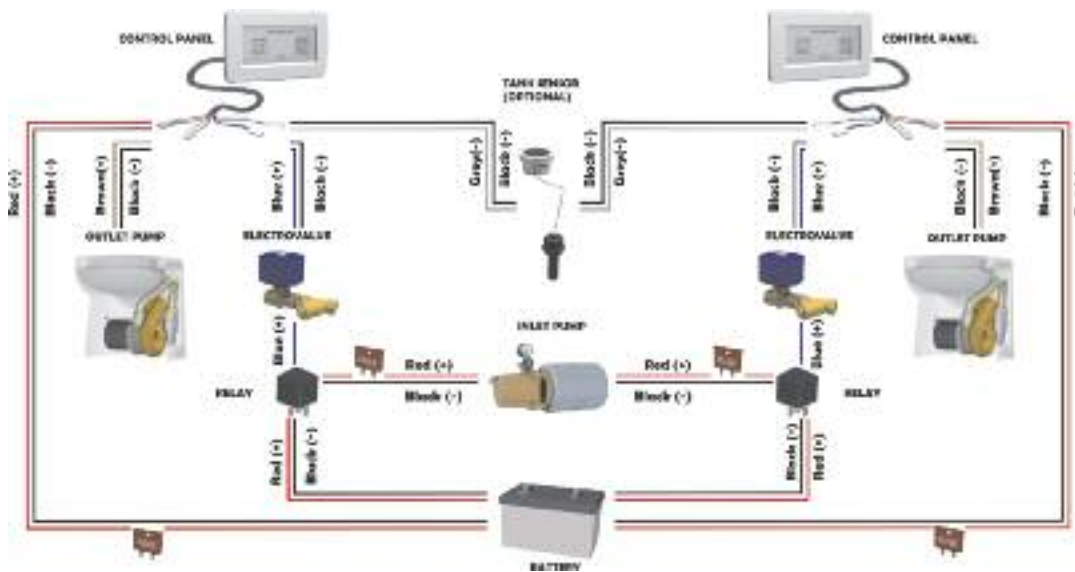

Sea water independent system

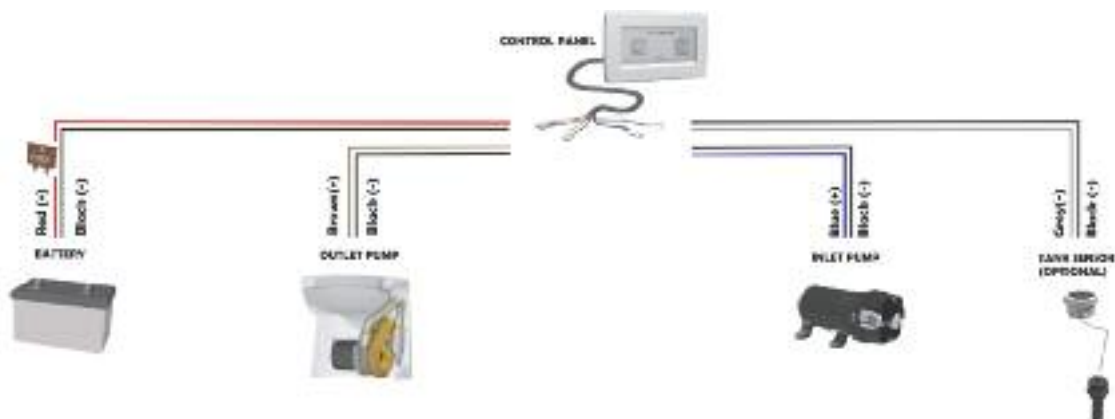

Technical specifications

Connections

HYDRAULIC CONNECTIONS

Inlet	Hose with ID of 20 mm (¾")
Outlet	Hose with ID of 40 mm (1½")

ELECTRICAL CONNECTIONS

Voltage	12 Vdc	24 Vdc	230 Vac
Minimal wire gauge up to 5 mt (<15 feet)	6 mm ² (9 AWG)	4 mm ² (11 AWG)	0,75 mm ² (18 AWG)
Minimal wire gauge over 5 mt (>15 feet)	10 mm ² (7 AWG)	6 mm ² (9 AWG)	1 mm ² (17 AWG)

Technical specification of the main components

VORTEX DISCHARGE PUMP

Hydraulic performances: up to 9 mt (29 feet) vertically, up to 80 mt (262 feet) horizontally	Voltage	12 Vdc	24 Vdc	230 Vac
	Absorption	40 A	25 A	3 A

INLET ELECTROVALVE

DIRECT ACTING Version (for both fresh water and sea water inlet systems)	Voltage	12 Vdc	24 Vdc	230 Vac
	Power	80 W	80 W	80 W
SERVO PILOTED Version (for fresh water inlet only)	Voltage	12 Vdc	24 Vdc	230 Vac
	Power	15 W	15 W	15 W

INDEPENDENT INLET PUMP

Voltage	12 Vdc	24 Vdc	230 Vac
Absorption	3,6 A	1,8 A	-

CENTRALIZED INLET PUMP (not supplied)

Recommended specifications	Working pressure	Min 1 bar - Max 3 bar
----------------------------	------------------	-----------------------

Flush controllers

The “Family” switch



Flush switch with a homely design and intuitive operation suitable for any user.

Even entertaining the occasional guest will not mean embarrassing and unavoidable explanations about how to use the toilet.

Available colours



White



Ivory



Gold



Chrome



Black

Control panels

Control panel with 1 button



This control panel causes the toilet to flush automatically, leaving a certain amount of water in the bowl.

It has a LED indicator that shows when the tank is full (connection to a tank level sensor is required).

It's supplied with a couple of frames in ivory and black colours. The panel is also compatible with the VIMAR Idea system frames.

Control panel with 2 buttons



The toilet activated by two button control panel leaves the bowl completely empty when not in use.

The "Before Use" button must be pressed to fill the bowl ready for use.

The "After Use" button causes the bowl to be flushed.

A LED indicator shows when the tank is full (connection to a tank level sensor is required). It's supplied with a couple of frames in ivory and black colours. The panel is also compatible with the VIMAR Idea system frames.

Holding tank sensor



The rising of the water level inside the tank generates pressure which activates the electrical contacts of the pressure switch.

The water level indicator pipe must be installed in the top of the tank, possibly at the centre.

The sensor is immune to false signals caused by the movement of the boat.

For total reliability, the sensor has been designed with no moving mechanical parts inside the tank.

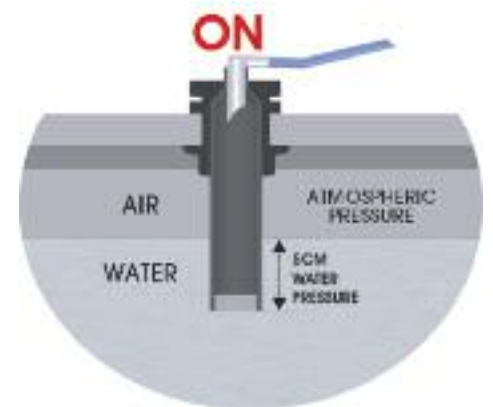
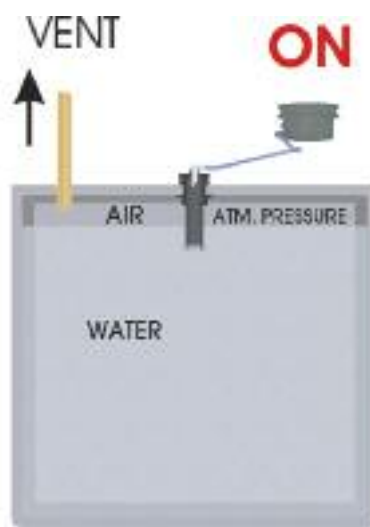
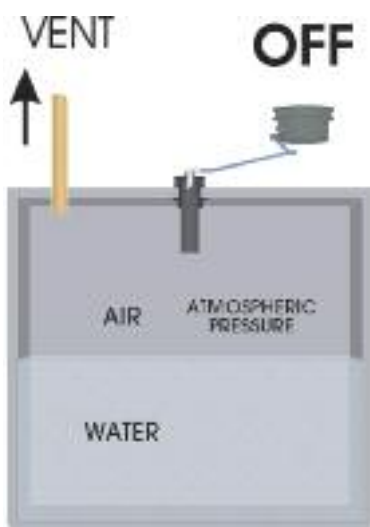

Electrical connections

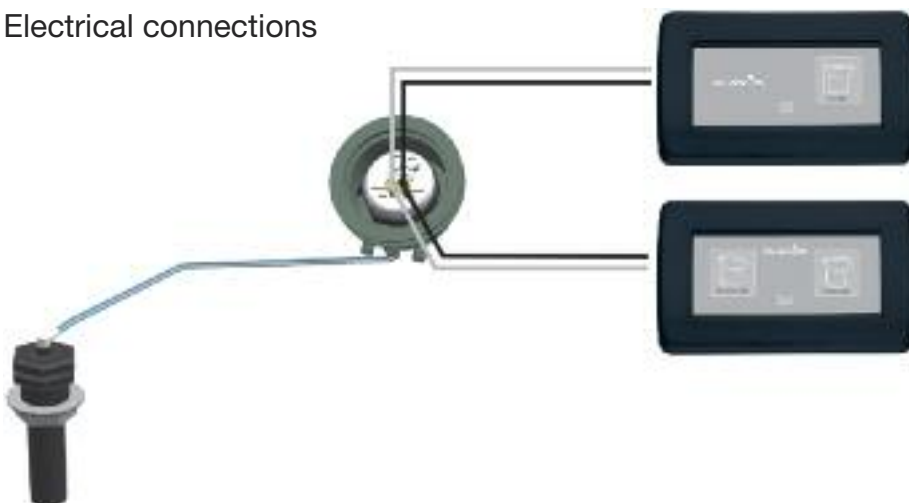

For further information about installation, see "Wiring" (page 38)

Toilet with integrated bidet water jet



Artic and Elite ranges toilets are also available in versions with the integrated bidet water jet.

Ventilation valves



Inlet ventilation valve

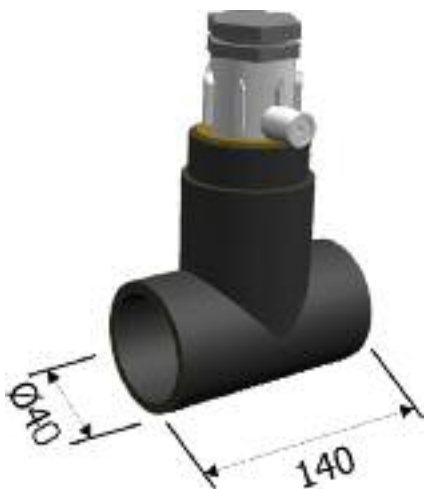

Outlet ventilation valve

In order to check when the installation of ventilation valves is required, see "Plumbing" (pages 35 and 37)

Exploded views

Standard toilet

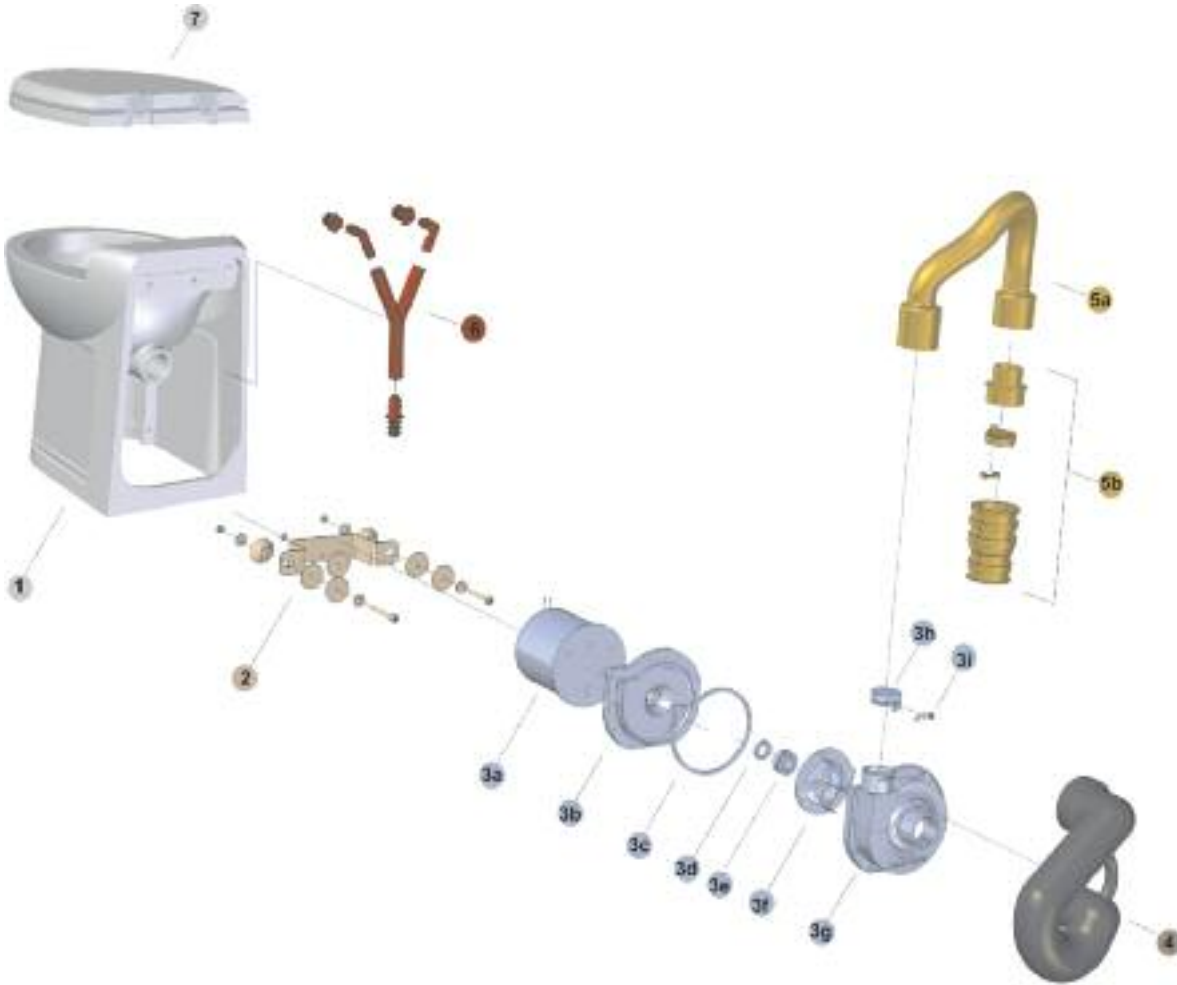

1	CERAMIC BOWL		
2	COMPLETE FIXING BRACKET		PW.026.00
3	VORTEX OUTLET PUMP	12v	PW.001.00
		24v	PW.002.00
		230v	PW.034.00
3a	Motor	12v	04.001.00
		24v	04.002.00
			04.025.00
		230v	04.025.00
3b	Flange for pump		02.005.00
3c	Sealing for pump		03.006.00
3d	Stationary seal for impeller		05.001.00
3e	Rotary seal for impeller		05.002.00
3f	Impeller		02.004.00
3g	Housing for pump		02.003.00
3h	One-way valve		03.005.00
3i	Clamp for one-way valve		02.009.00
4	SIPHON HOSE		PW.003.00
5	DISCHARGE HOSE COMPLETE		PW.005.00
5a	Discharge hose		03.002.00
5b	One-way valve - Assembly		PW.006.00
6	INLET PIPE		PW.007.00
7	SEAT & COVER		



Toilet with integrated bidet water jet



1	WATER MIXER	PB.012.00
2	WATER JET	PB.013.00



24 Artic



28 Elite

Wall-mounted toilet

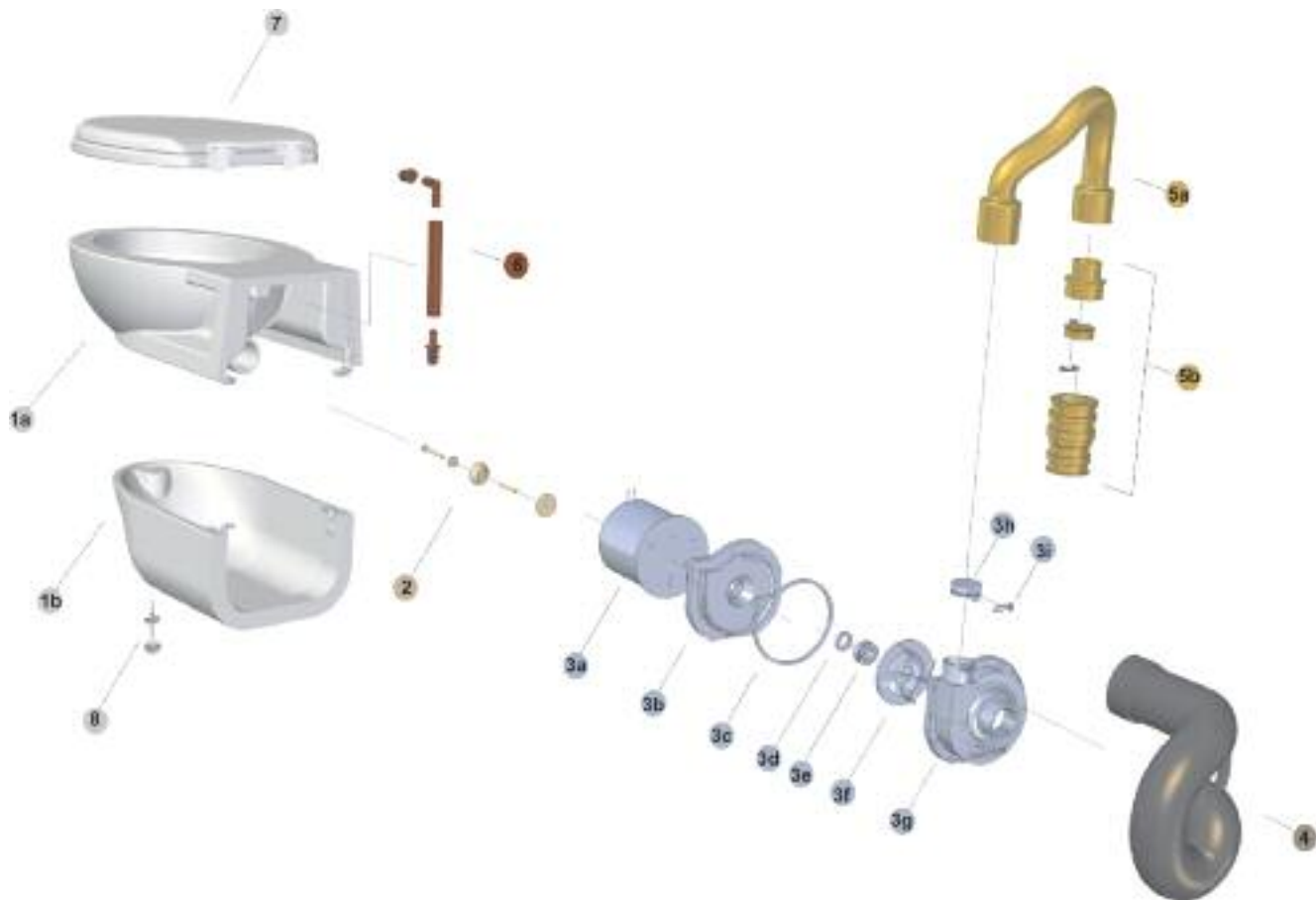

1	CERAMIC BOWL		
1a	Bowl		
1b	Shell		
2	COMPLETE FIXING BRACKET		PW.027.00
3	VORTEX OUTLET PUMP	12v	PW.001.00
		24v	PW.002.00
		230v	PW.034.00
3a	Motor	12v	04.001.00
		24v	04.002.00
		230v	04.025.00
3b	Flange for pump		02.005.00
3c	Sealing for pump		03.006.00
3d	Stationary seal for impeller		05.001.00
3e	Rotary seal for impeller		05.002.00
3f	Impeller		02.004.00
3g	Housing for pump		02.003.00
3h	One-way valve		03.005.00
3i	Clamp for one-way valve		02.009.00
4	WALL-MOUNTED TOILET SIPHON HOSE		PW.004.00
5	DISCHARGE HOSE COMPLETE		PW.005.00
5a	Discharge hose		03.002.00
5b	One-way valve - Assembly		PW.006.00
6	WALL-MOUNTED TOILET INLET PIPE		PW.008.00
7	SEAT & COVER		
8	CLAMP FOR CERAMIC SHELL		02.033.00



Carbon toilet

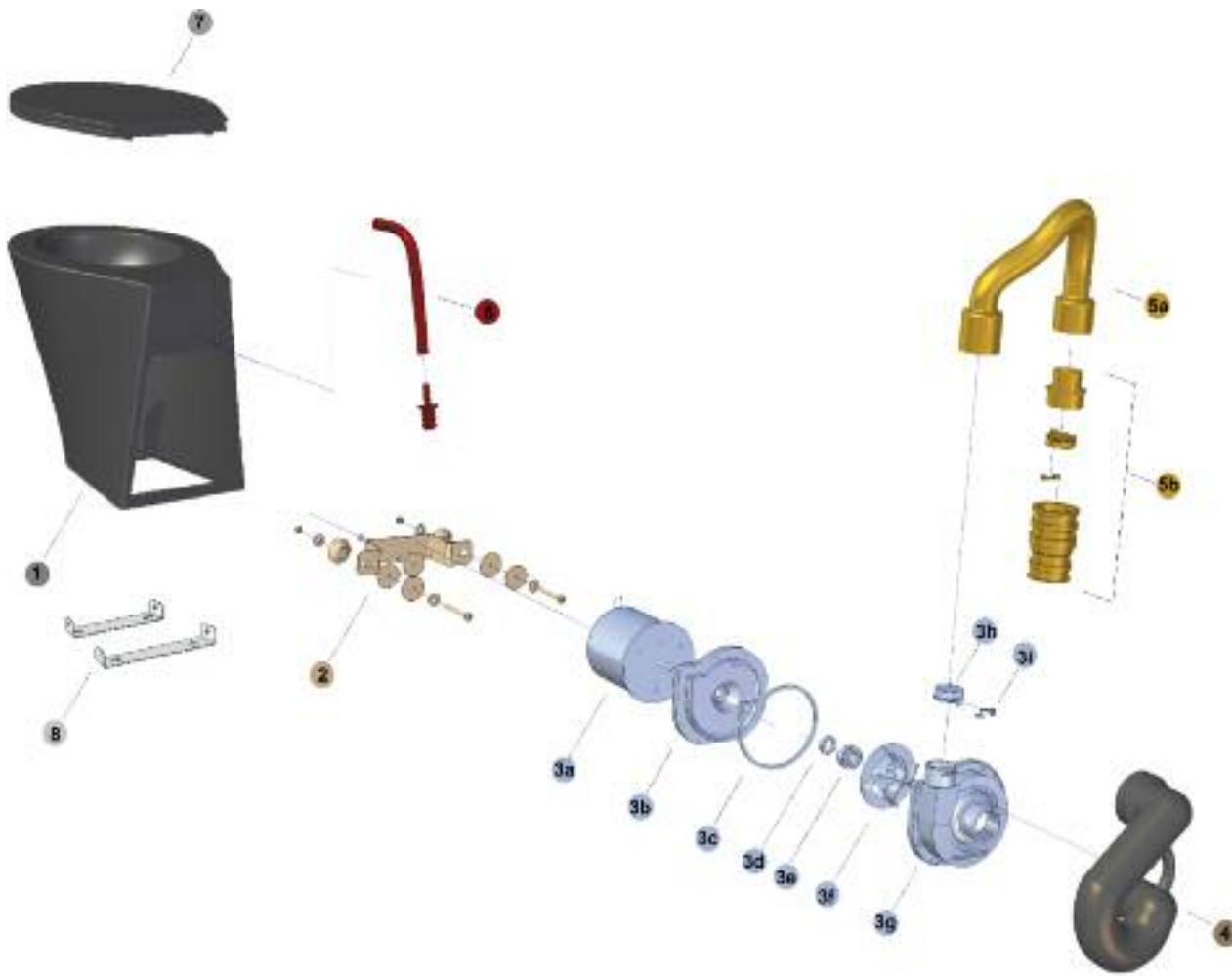

1	CARBON BOWL		
2	COMPLETE FIXING BRACKET		PW.026.00
3	VORTEX OUTLET PUMP	12v	PW.001.00
		24v	PW.002.00
		230v	PW.034.00
3a	Motor	12v	04.001.00
		24v	04.002.00
		230v	04.025.00
3b	Flange for pump		02.005.00
3c	Sealing for pump		03.006.00
3d	Stationary seal for impeller		05.001.00
3e	Rotary seal for impeller		05.002.00
3f	Impeller		02.004.00
3g	Housing for pump		02.003.00
3h	One-way valve		03.005.00
3i	Clamp for one-way valve		02.009.00
4	SIPHON HOSE		PW.003.00
5	DISCHARGE HOSE COMPLETE		PW.005.00
5a	Discharge hose		03.002.00
5b	One-way valve - Assembly		PW.006.00
6	CARBON TOILET WATER INLET		PW.009.00
7	SEAT & COVER IN CARBON		
8	CARBON TOILET FIXING BRACKETS		PW.037.00



Grey water transfer unit

Pro-Lift **MONO**
TWIN

Automatic pumping device.

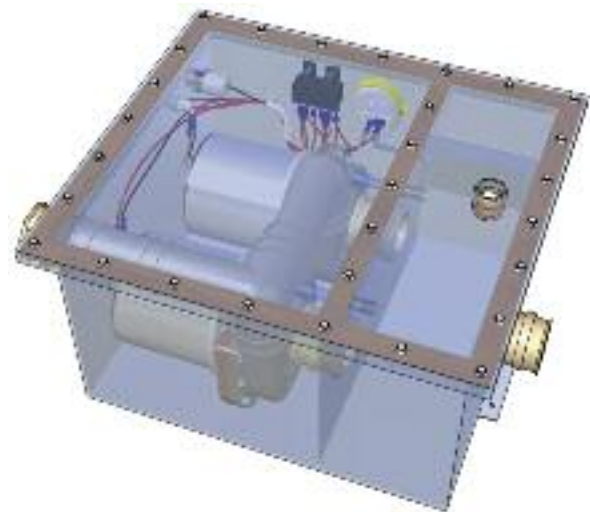
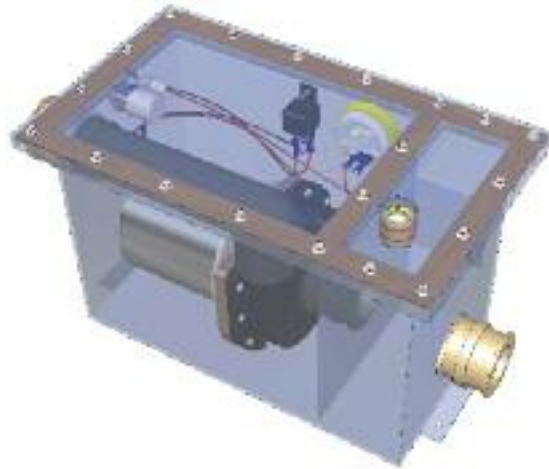

Pro-Lift is a professional-strength pump, necessary when the gradient to reach the water tank by force of gravity is absent. Pro-Lift is a completely sealed, stainless steel box that can be installed in any environment.

The unit comprises one or two Vortex pumps, extremely quiet and powerful, capable of discharging both grey or black water. That allows to discharge without any problem acidic or greasy water, detergents and small organic residues.

Pro-Lift is furnished with an integrated one-way valve. In order to guarantee the highest reliability, the activation of the automatic unit Pro-Lift has been designed to operate with a pneumatic system, without any movable mechanical parts inside the tank.

Pro-Lift is available in the **MONO** version, of a smaller size, and the **TWIN** version, ensuring higher performances for heavy duty usage.

Application

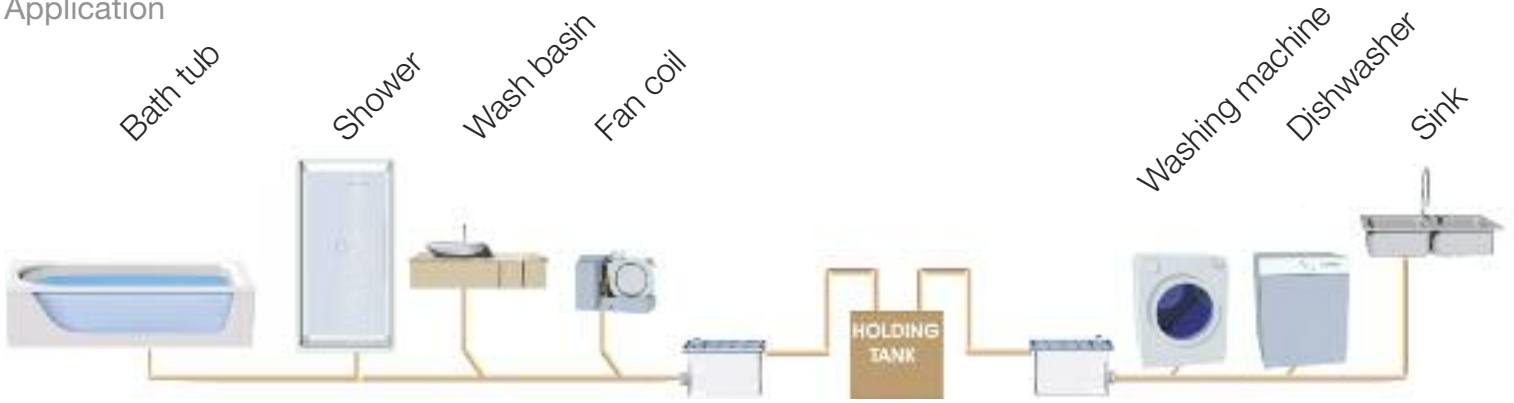

Pro-Lift Mono dimensions

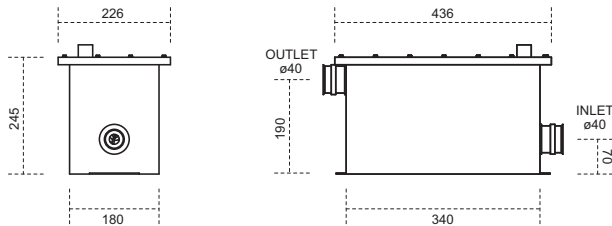

Pro-Lift Twin dimensions

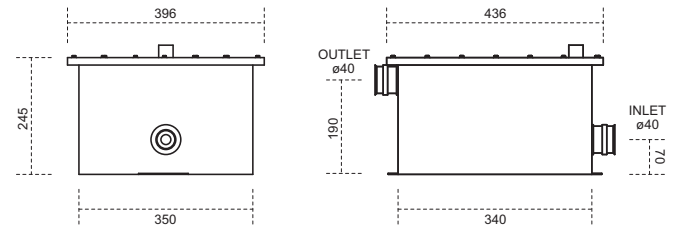

Pro-Lift Mono exploded view



Pro-Lift Twin exploded view

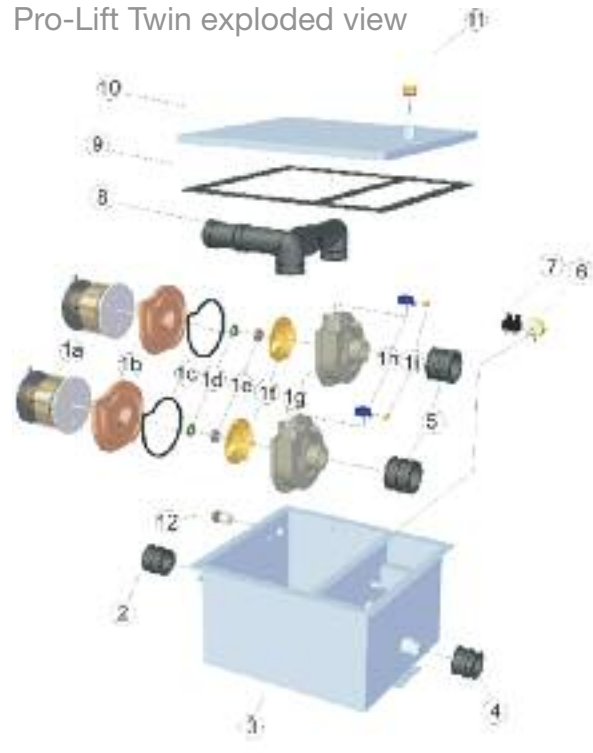

1	VORTEX OUTLET PUMP	12v	PW.038.00
		24v	PW.039.00
		230v	PW.034.00
1a	Motor	12v	04.026.00
		24v	04.027.00
		230v	04.025.00
1b	Flange for pump		02.005.00
1c	Sealing for pump		03.006.00
1d	Stationary seal for impeller		05.001.00
1e	Rotary seal for impeller		05.002.00
1f	Impeller		02.004.00
1g	Housing for pump		02.003.00
1h	One-way valve		03.005.00
1i	Clamp for one-way valve		02.009.00
2	OUTLET CONNECTION HOSE		03.009.00

3	STAINLESS STEEL BOX	MONO	06.003.00
		TWIN	06.015.00
4	INLET CONNECTION HOSE		03.009.00
5	INTERNAL INLET HOSE FOR PUMP		03.010.00
6	PRESSURE SWITCH		04.007.00
7	RELAY	12v	04.011.00
		24v	04.012.00
8	INTERNAL OUTEL HOSE FOR PUMP	MONO	03.014.00
		TWIN	03.019.00
9	SEAL FOR BOX	MONO	03.008.00
		TWIN	03.020.00
10	STAINLESS STEEL COVER	MONO	06.004.00
		TWIN	06.016.00
11	VENTILATION VALVE		05.056.00
12	MANUAL SWITCH		04.022.00